



VARISCITE LTD

7" TFT LVDS DISPLAY WITH PCAP

Variscite PN: VLCD-CAP-GLD

Display Model: SGD GKTW70SDAE4SE





Product Specification				
	Model: GKTW70SDAE4SE	Rev. No.	Issued Date.	Page.
		B	2014.Nov.13	1 / 22

Thin-Film-Transistor LCD Module
Model: GKTW70SDAE4SE

Acceptance

Solomon Goldentek Display Corp.
NO. 18 Ta-Yeh St., Ta-Fa Industrial Park, Ta-Liao
Hsiang, Kaohsiung Hsien 831, TAIWAN , R.O.C.
 FAX: 886-7-7886800

Approved and Checked by

Approved by	Checked by		Made by
			

SOLOMON GOLDENTEK DISPLAY CORP. SGD®

Product Specification				
	Model: GKTW70SDAE4SE	Rev. No.	Issued Date.	Page.
		B	2014.Nov.13	2 / 22

Revise Records

Rev.	Date	Contents	Written	Approved
A	2014/09/15	Preliminary Specification	Carl Lin	Roger Yang
B	2014/11/13	Modify 9. Dimensional Outlines	Carl Lin	Roger Yang
		Modify 7. Projected Capacitive Touch Panel IC:FT5406DQ9->FT5446		

Special Notes

Note1.	
Note2.	
Note3.	
Note4.	
Note5.	

Product Specification				
	Model: GKTW70SDAE4SE	Rev. No.	Issued Date.	Page.
		B	2014.Nov.13	3 / 22

Contents

1.	General Description and Features	4
1.1	Features	4
1.2	LCD Module	4
2.	Mechanical Information	4
3.	Electrical Specifications	5
3.1	Absolute Max. Ratings	5
3.2	LVDS Switching Characteristics	11
4.	Optical Characteristics	13
4.1	Optical characteristic of the LCD	13
5.	I/O Terminal	16
5.1	Pin Assignment	16
5.2	Back-light Dimming	17
5.3	Block Diagram	18
6.	Displayed Color and Input Data	19
7.	Projected Capacitive Touch Panel	20
8.	Reliability Condition	20
9.	Dimensional Outlines	22

Product Specification				
	Model: GKTW70SDAE4SE	Rev. No.	Issued Date.	Page.
		B	2014.Nov.13	4 / 22

1. General Description and Features

GKTW70SDAE4SE is a transmissive type color active matrix TFT (Thin Film Transistor) liquid crystal display (LCD) that uses amorphous silicon TFT as a switching device. This model is composed of a TFT-LCD module, a receiver circuit, and a back-light unit. Graphics and texts can be displayed on a WVGA 800 (W) x 3 x 480 (H) dots (16:9 aspect ratio) with 262,144 colors by supplying 18 bits data signal (6bits/each color). The following table described the features of GKTW70SDAE4SE.

1.1 Features

- Transmissive and back-light with 27 LEDs are available.
- TN (Twisted Nematic) mode.
- LVDS Receiver 18 bit Interface.
- Back-light Dimming control
- Projected Capacitive Touch Panel

1.2 LCD Module

Item	Specification	Unit
Screen Size	7.0 inches	Diagonal
Display Resolution	800 (H) x 480 (V)	Pixel
Active Area	153.6 (H) x 86.64 (V)	mm
Outline Dimension	171.4(H) x 109.9(V) x7.35 (T)	mm
Display Mode	Normally white mode/ Transmissive	--
Surface Treatment	Glass 6H(min.)	--
Pixel Arrangement	R,G,B Vertical Stripe	--
Pixel Size	192 x 180.5	um
Display Color	262k	--
Gray Scale Inversion Direction	6 o'clock	--
Viewing Direction	12 o'clock	
Input Interface	LVDS Receiver 18 bit Interface	--

2. Mechanical Information

Item	Min.	Typ.	Max.	Unit	Note
Module Size	Horizontal (H)	--	(171.4)	--	mm
	Vertical (V)	--	(109.9)	--	mm
	Thickness (T)	--	(7.35)	--	mm
Weight	--	(150)	--	g	--

Note (1) Not Include Component. Refer to the Outline Dimension Drawing as attached.

Product Specification				
	Model: GKTW70SDAE4SE	Rev. No.	Issued Date.	Page.
		B	2014.Nov.13	5 / 22

3. Electrical Specifications

3.1 Absolute Max. Ratings

3.1.1 Absolute Ratings of Environment

If the operating condition exceeds the following absolute maximum ratings, the TFT LCD module may be damaged permanently.

($T_a = 25 \pm 2^\circ\text{C}$, $V_{SS} = \text{GND} = 0$)

Item	Symbol	Min.	Max.	Unit	Note
Storage temperature	T_{STG}	-30	80	$^\circ\text{C}$	(1)
Operating temperature	T_{OPR}	-20	70	$^\circ\text{C}$	(1,2,3)

Note (1) 95 % RH Max. ($40^\circ\text{C} \geq T_a$). Maximum wet-bulb temperature at 39°C or less. ($T_a > 40^\circ\text{C}$) No condensation.

Note (2) In case of below 0° , the response time of liquid crystal (LC) becomes slower and the color of panel becomes darker than normal one. Level of retardation depends on temperature, because of LC's character

Note (3) Only operation is guaranteed at operating temperature. Contrast, response time, another display quality are evaluated at $+25^\circ\text{C}$.

Product Specification				
	Model: GKTW70SDAE4SE	Rev. No.	Issued Date.	Page.
		B	2014.Nov.13	6 / 22

3.1.2 Electrical Absolute Maximum Ratings

(V_{SS}=GND=0)

Parameter	Symbol	Min.	Max.	Unit	Remark
Power supply Logic voltage	VCC	-0.3	4.0	V	
Power supply LED voltage	VLED	-0.3	6.0	V	
Permissive input ripple voltage	V _{RF}	--	100	mVp-p	V _{CC} =+3.0V

Display On/Off Sequence :

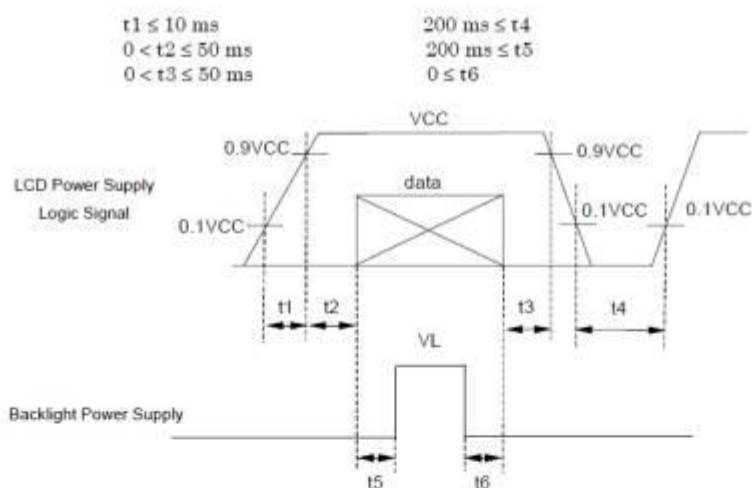

SOLOMON GOLDENTEK DISPLAY CORP. **SGD**[®]

Product Specification				
	Model: GKTW70SDAE4SE	Rev. No.	Issued Date.	Page.
		B	2014.Nov.13	7 / 22

3.1.3 DC Electrical Characteristics of the TFT LCD

(Ta=25±2°C, V_{SS}=GND=0)

Item	Symbol	Min.	Typ.	Max.	Unit	Remark
Power supply Logic Voltage	VCC	3.0	3.3	3.6	V	
Power supply LED Voltage	VLED	4.5	5	5.5	V	
Input Voltage for logic	H Level	V _{IH}	0.7xVCC	-	VCC	V
	L Level	V _{IL}	0	-	0.3xVCC	V
Power Supply current	ICC	-	(170)	-	mA	Note 1
Power Supply current	I _{LED}	-	(450)	(500)	mA	
LED Life time	-	(30000)	-	-	Hr	Note 2

Note1: f_v =60Hz , Ta=25°C , Display pattern : Black pattern



Note2: The environmental conducted under ambient air flow ,at Ta=25±2°C,60%RH±5%

Product Specification				
	Model: GKTW70SDAE4SE	Rev. No.	Issued Date.	Page.
		B	2014.Nov.13	8 / 22

3.1.4 Timing Condition (DE only mode)

Signal	Parameter	Symbol	Min.	Typ.	Max.	Unit.	Remark
DCLK	DCLK cycle time	T_{cph}	25	-	-	ns	
	DCLK Frequency	f_{clk}	-	30	40	MHz	
	DCLK High plus width	T_{cwh}	40	50	60	%	
Horizontal	HSD setup time	T_{hst}	8	-	-	ns	
	HSD hold time	T_{hhd}	8	-	-	ns	
	Horizontal display area	t_{hd}	-	800	-	Tcph	
	HSD period time	t_h	-	928	-	Tcph	
	HSD pulse width	t_{hpw}	1	48	-	Tcph	
	HSD back porch	t_{hb}	-	40	-	Tcph	
	HSD front porch	t_{hfp}	-	40	-	Tcph	
	Vertical	VSD setup time	T_{vst}	8	-	-	ns
VSD hold time		T_{vhd}	8	-	-	ns	
Vertical display area		t_{vd}	-	480	-	th	
VSD period time		t_v	-	525	-	th	
VSD pulse width		t_{vpw}	-	3	-	th	
VSD back porch		t_{vb}	-	29	-	th	
VSD front porch		t_{vfp}	-	13	-	th	
DE	DE setup time	T_{esu}	8	-	-	ns	
	DE hold time	T_{ehd}	8	-	-	ns	
DATA	Data setup time	T_{dsu}	8	-	-	ns	
	Data hold time	T_{dhd}	8	-	-	ns	

Product Specification				
	Model: GKTW70SDAE4SE	Rev. No.	Issued Date.	Page.
		B	2014.Nov.13	9 / 22

3.1.5 Timing Characteristic

3.1.5.1 DE and RGB Input Timing

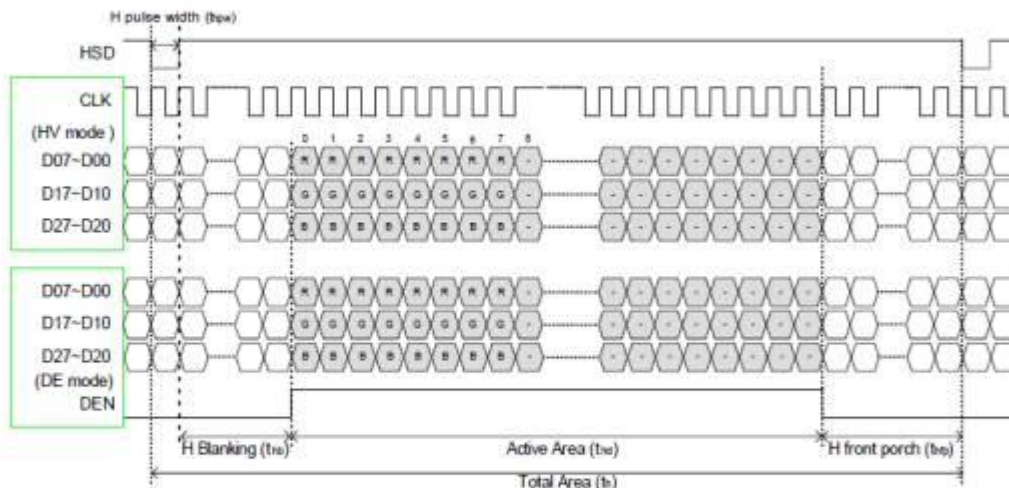
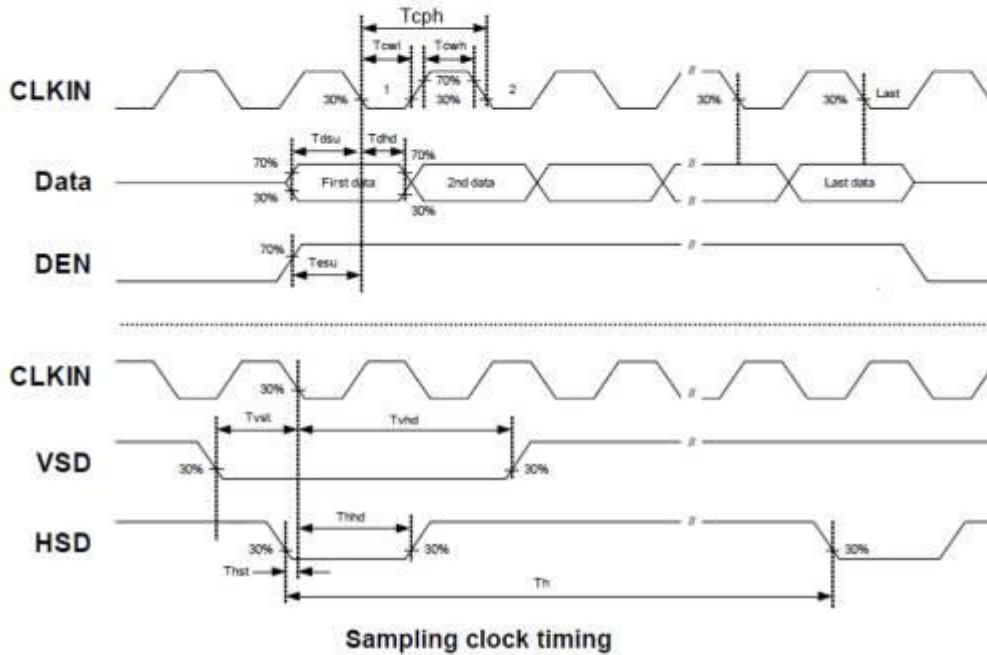

Product Specification				
	Model: GKTW70SDAE4SE	Rev. No.	Issued Date.	Page.
		B	2014.Nov.13	10 / 22

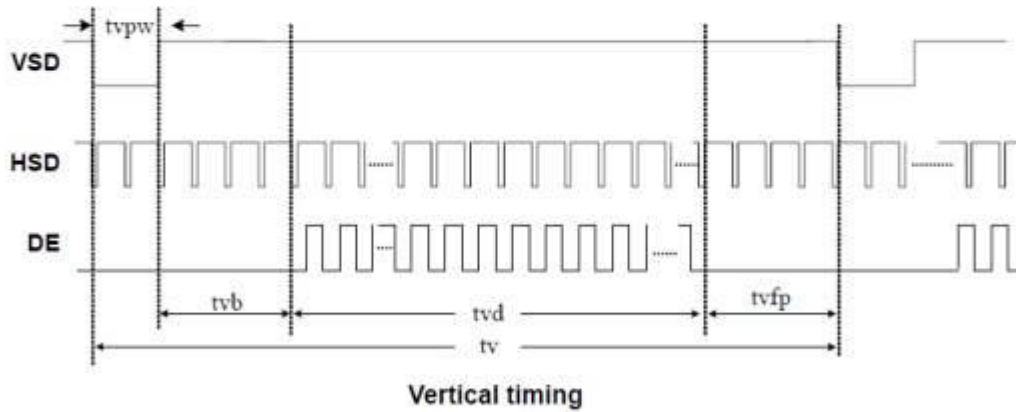

SOLOMON GOLDENTEK DISPLAY CORP. **SGD**[®]

Product Specification				
	Model: GKTW70SDAE4SE	Rev. No.	Issued Date.	Page.
		B	2014.Nov.13	11 / 22

3.2 LVDS Switching Characteristics

3.2.1 LVDS Timing Condition

Symbol	Parameter	Min.	Typ.	Max.	Unit.	Note
tRCP	CLK OUT Period	VCC = 3.0 - 3.6V	11.76	T	50.0	ns
		VCC = 2.5 - 3.6V	14.28	T	50.0	ns
tRCH	CLK OUT High Time	-	4T/7	-	ns	
tRCL	CLK OUT Low Time	-	3T/7	-	ns	
tRCD	RCLK +/- to CLK OUT Delay	-	5T/7	-	ns	
tRS	TTL Data Setup to CLK OUT	0.35T-0.3	-	-	ns	
tRH	TTL Data Hold from CKL OUT	0.45T-1.6	-	-	ns	
tTLH	TTL Low to High Transition Time	-	2.0	3.0	ns	
tTHL	TTL High to Low Transition Time	-	1.8	3.0	ns	
tRIP1	Input Data Position0 (T = 11.76ns)	-0.4	0.0	0.4	ns	
tRIP0	Input Data Position1 (T = 11.76ns)	T/7-0.4	T/7	T/7+0.4	ns	
tRIP6	Input Data Position2 (T = 11.76ns)	2T/7-0.4	2T/7	2T/7+0.4	ns	
tRIP5	Input Data Position3 (T = 11.76ns)	3T/7-0.4	3T/7	3T/7+0.4	ns	
tRIP4	Input Data Position4 (T = 11.76ns)	4T/7-0.4	4T/7	4T/7+0.4	ns	
tRIP3	Input Data Position5 (T = 11.76ns)	5T/7-0.4	5T/7	5T/7+0.4	ns	
tRIP2	Input Data Position6 (T = 11.76ns)	6T/7-0.4	6T/7	6T/7+0.4	ns	
tRPLL	Phase Lock Loop Set			10.0	ms	

Product Specification				
	Model: GKTW70SDAE4SE	Rev. No.	Issued Date.	Page.
		B	2014.Nov.13	12 / 22

3.2.2 LVDS AC Timing

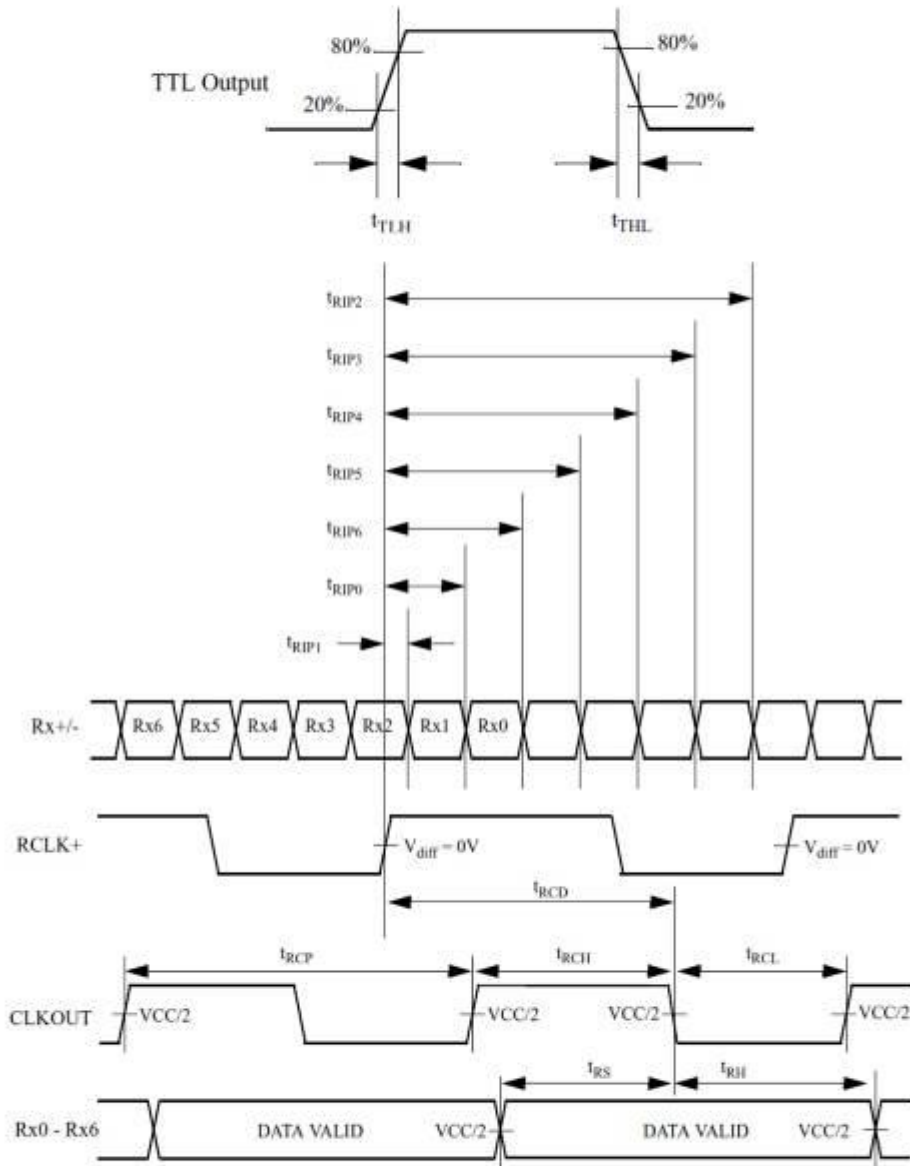

SOLOMON GOLDENTEK DISPLAY CORP. **SGD**[®]

Product Specification				
	Model: GKTW70SDAE4SE	Rev. No.	Issued Date.	Page.
		B	2014.Nov.13	13 / 22

4. Optical Characteristics

4.1 Optical characteristic of the LCD

The following items are measured under stable conditions. The optical characteristics should be measured in a dark room or equivalent state with the methods.

Measuring equipment: BM-7A

Item	Symbol	Condition	Min	Type	Max	Unit	Note	
Brightness	B		(400)	(440)	--	cd/m ²		
Response time	T _r	θ=0°	-	5	7	ms	.	
	T _f		--	20	28	ms		
Contrast ratio	CR	At optimized viewing angle	(400)	(500)	--	--		
Luminance Uniformity	ΔL		70	80		%		
Color Chromaticity (CIE 1931)	White	θ=0° Normal Viewing Angle	W _x	(0.280)	(0.310)	(0.340)	--	BM-7A
			W _y	(0.330)	(0.360)	(0.390)		
Viewing Angle (6H)	Hor.	CR≥10	θ _R	60	70	--	Degree	
			θ _L	60	70	--		
	Ver.		θ _U	40	50	--		
			θ _D	50	60	--		

Product Specification				
	Model: GKTW70SDAE4SE	Rev. No.	Issued Date.	Page.
		B	2014.Nov.13	14 / 22

a. Test equipment setup

After stabilizing and leaving the panel alone shall be warmed up for the stable operation of LCM, the measurement should be executed. Measurement should be executed in a stable, windless, and dark room. Optical specifications are measured by Topcon BM-7A(fast) with a viewing angle of 2° at a distance of 50cm and normal direction.

b. Definition of response time: Tr and Tf

The response time is defined as the following figure and shall be measured by switching the input signal for "black" and "white".

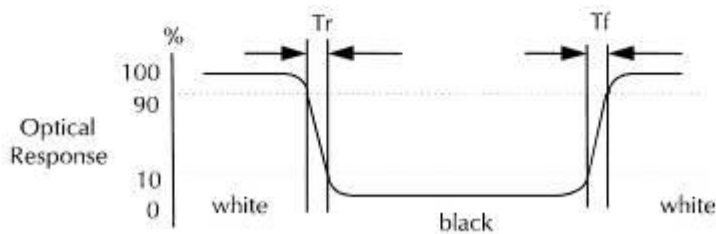

c. Definition of contrast ratio:

$$\text{Contrast Ratio (CR)} = \frac{\text{Brightness measured when LCD is at "white state"}}{\text{Brightness measured when LCD is at "black state"}}$$

d. Measured at the center area of the panel when all the input terminals of LCD panel are electrically opened.

Product Specification				
	Model: GKTW70SDAE4SE	Rev. No.	Issued Date.	Page.
		B	2014.Nov.13	15 / 22

e. View Angle

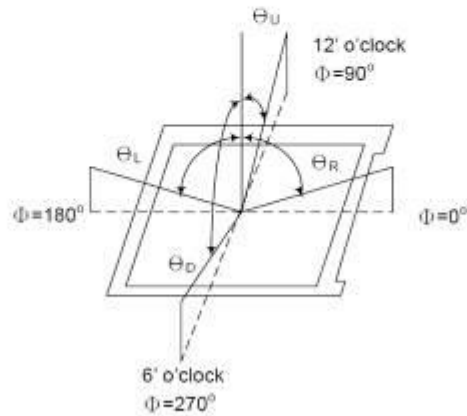

f. Definition of Luminance of White: Luminance of white at the center points

Light Source of Back-Light Unit	LED Type
---------------------------------	----------

g. Definition of White Uniformity

$$\text{White Uniformity} = \frac{\text{Min. luminance of white among 9-points}}{\text{Max. luminance of white among 9-points}} \times 100\%$$

Product Specification				
	Model: GKTW70SDAE4SE	Rev. No.	Issued Date.	Page.
		B	2014.Nov.13	16 / 22

5. I/O Terminal

5.1 Pin Assignment

Pin No.	Symbol	I/O	Function	Remark
1	VCC	P	Power Supply Logic voltage +3.3V	
2	VCC	P	Power Supply Logic voltage +3.3V	
3	VSS	P	Ground	
4	VSS	P	Ground	
5	RIN0-	I	Negative LVDS differential data input	
6	RIN0+	I	Positive LVDS differential data input	
7	VSS	P	Ground	
8	RIN1-	I	Negative LVDS differential data input	
9	RIN1+	I	Positive LVDS differential data input	
10	VSS	P	Ground	
11	RIN2-	I	Negative LVDS differential data input	
12	RIN2+	I	Positive LVDS differential data input	
13	VSS	P	Ground	
14	RCLK-	I	Negative LVDS differential clock input	
15	RCLK+	I	Positive LVDS differential clock input	
16	VSS	P	Ground	
17	VLED	P	Power Supply LED voltage +5V	
18	VLED	P	Power Supply LED voltage +5V	
19	ADJ	I	Back-light Dimming control	
20	VSS	P	Ground	

I: Input, O: Output, P: Power

Notes:

- 1) VSS Pin must ground contact, can not be floating.

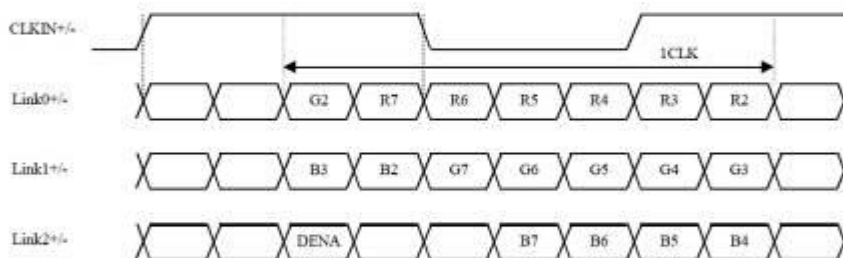

Product Specification				
	Model: GKTW70SDAE4SE	Rev. No.	Issued Date.	Page.
		B	2014.Nov.13	17 / 22

5.2 Back-light Dimming

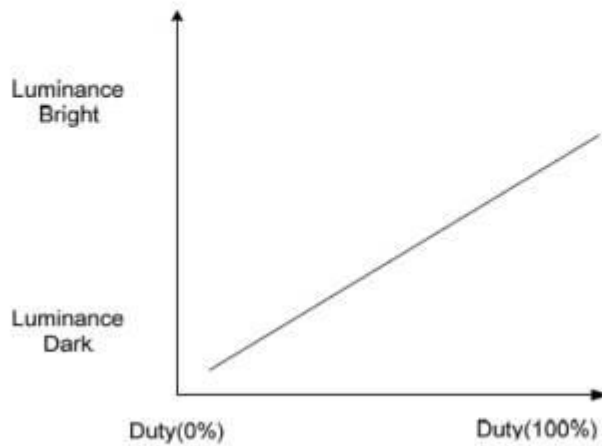

Note 2: ADJ signal=0~3.3V, Operating frequency:1KHz

Product Specification				
	Model: GKTW70SDAE4SE	Rev. No.	Issued Date.	Page.
		B	2014.Nov.13	18 / 22

5.3 Block Diagram

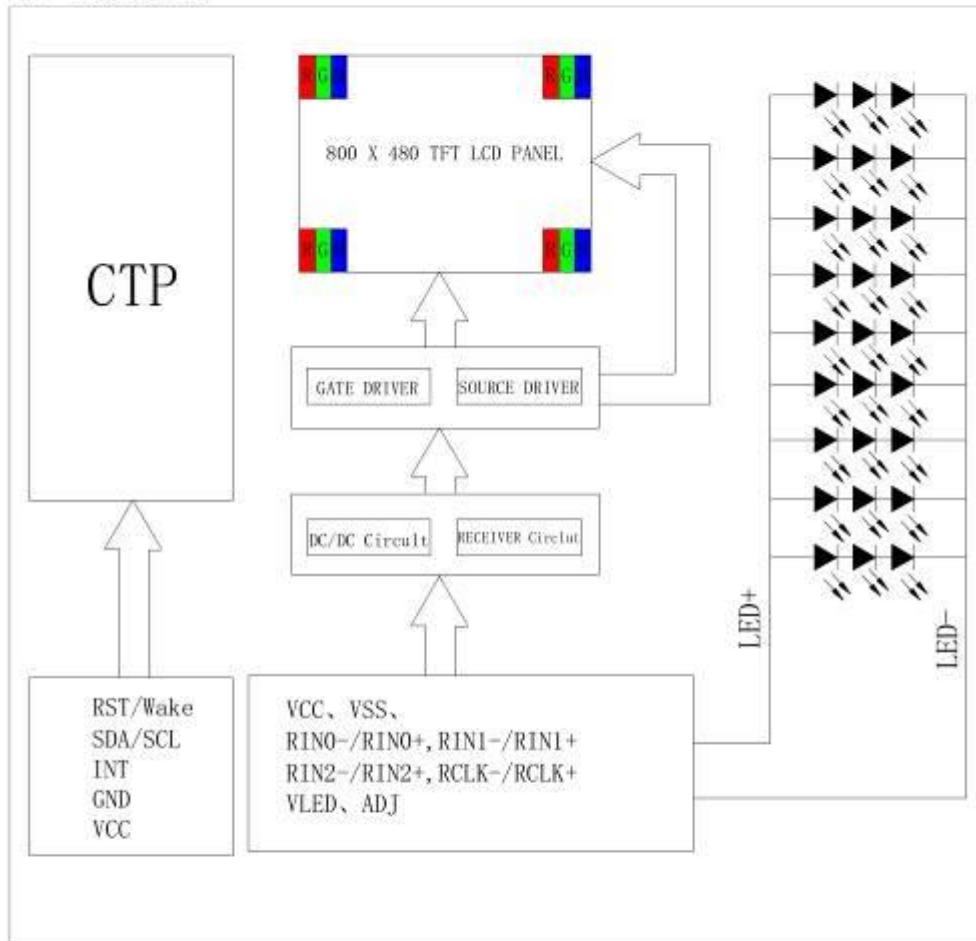

Product Specification				
	Model: GKTW70SDAE4SE	Rev. No.	Issued Date.	Page.
		B	2014.Nov.13	19 / 22

6. Displayed Color and Input Data

	Color & Gray Scale	Data Signal																	
		R5	R4	R3	R2	R1	R0	G5	G4	G3	G2	G1	G0	B5	B4	B3	B2	B1	B0
Basic Color	Black	0	0	0	0	0	0	0	0	0	0	0	0	0	0	0	0	0	0
	Red(0)	1	1	1	1	1	1	0	0	0	0	0	0	0	0	0	0	0	0
	Green(0)	0	0	0	0	0	0	1	1	1	1	1	1	0	0	0	0	0	0
	Blue(0)	0	0	0	0	0	0	0	0	0	0	0	0	1	1	1	1	1	1
	Cyan	0	0	0	0	0	0	1	1	1	1	1	1	1	1	1	1	1	1
	Magenta	1	1	1	1	1	1	0	0	0	0	0	0	1	1	1	1	1	1
	Yellow	1	1	1	1	1	1	1	1	1	1	1	1	0	0	0	0	0	0
	White	1	1	1	1	1	1	1	1	1	1	1	1	1	1	1	1	1	1
Red	Black	0	0	0	0	0	0	0	0	0	0	0	0	0	0	0	0	0	0
	Red(62)	0	0	0	0	0	1	0	0	0	0	0	0	0	0	0	0	0	0
	Red(61)	0	0	0	0	1	0	0	0	0	0	0	0	0	0	0	0	0	0
	:	:	:	:	:	:	:	:	:	:	:	:	:	:	:	:	:	:	:
	Red(31)	0	1	1	1	1	1	0	0	0	0	0	0	0	0	0	0	0	0
	:	:	:	:	:	:	:	:	:	:	:	:	:	:	:	:	:	:	:
Green	Black	0	0	0	0	0	0	0	0	0	0	0	0	0	0	0	0	0	0
	Green(62)	0	0	0	0	0	0	0	0	0	0	0	1	0	0	0	0	0	0
	Green(61)	0	0	0	0	0	0	0	0	0	0	1	0	0	0	0	0	0	0
	:	:	:	:	:	:	:	:	:	:	:	:	:	:	:	:	:	:	:
	Green(31)	0	0	0	0	0	0	0	1	1	1	1	0	0	0	0	0	0	0
	:	:	:	:	:	:	:	:	:	:	:	:	:	:	:	:	:	:	:
Blue	Black	0	0	0	0	0	0	0	0	0	0	0	0	0	0	0	0	0	0
	Blue(62)	0	0	0	0	0	0	0	0	0	0	0	0	0	0	0	0	0	1
	Blue(61)	0	0	0	0	0	0	0	0	0	0	0	0	0	0	0	0	0	1
	:	:	:	:	:	:	:	:	:	:	:	:	:	:	:	:	:	:	:
	Blue(31)	0	0	0	0	0	0	0	0	0	0	0	0	0	1	1	1	1	1
	:	:	:	:	:	:	:	:	:	:	:	:	:	:	:	:	:	:	:
Blue	Blue(1)	0	0	0	0	0	0	0	0	0	0	0	0	1	1	1	1	1	0
	Blue(0)	0	0	0	0	0	0	0	0	0	0	0	0	1	1	1	1	1	1

0 : Low level voltage, 1 :High level voltage

Each basic color can be displayed in 64 gray scales from 6 bit data signals. With the combination of total 18 bit data signals, the 262,144-color display can be achieved on the screen.

Product Specification				
	Model: GKTW70SDAE4SE	Rev. No.	Issued Date.	Page.
		B	2014.Nov.13	20 / 22

7. Projected Capacitive Touch Panel

7.1 Main Feature

Item	Specification	Unit
Screen Size	7 inches	Diagonal
Type	Transparent Type Projected Capacitive Touch Panel	--
Input Mode	Human's Finger	--
Active Area	156.48 x 88.32	mm
Module Outline	171.4(H) x 109.9(V)	mm
Interface	I2C	--
Cover glass pencil-hardness	6H(min)	--
Digital Power Supply	3.3V DC (typ)	V
Power Consumption	(13.2)	mA
IC solution	FT5446	

7.2 Pin Assignments and Definitions

Item	Name	I/O	Unit
1	RST/WAKE	I	Reset /Wake Up
2	SDA	I/O	I2C Data Pin
3	SCL	I/O	I2C CLK Pin
4	INT	O	I2C Interrupt Pin
5	VDD	P	Power Supply Voltage
6	GND	P	Ground

8. Reliability Condition

No change on display and in operation under the following test condition.

SOLOMON GOLDENTEK DISPLAY CORP. SGD®

Product Specification				
	Model: GKTW70SDAE4SE	Rev. No.	Issued Date.	Page.
		B	2014.Nov.13	21 / 22

Condition: Unless otherwise specified, tests will be conducted under the following condition.

Temperature: 20±5°C.

Humidity: 65±5%RH.

Tests will be not conducted under functioning state.

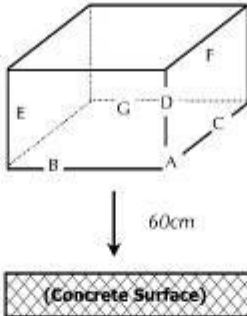
No.	Parameter	Condition	Notes
1	High Temperature Operating	70°C±2°C, 240hrs (Operation state).	
2	Low Temperature Operating	-20°C±2°C, 240hrs (Operation state).	1
3	High Temperature Storage	80°C±2°C, 240hrs.	2
4	Low Temperature Storage	-30°C±2°C, 240hrs.	1,2
5	High Temperature and High Humidity Storage	60°C±2°C, 90%, 240hrs.	1,2
6	Vibration Test	Total fixed amplitude: 1.5mm. Vibration Frequency: 10-55Hz. One cycle 60 seconds to 3 direction of X, Y, Z each 15 minutes.	3
7.	Drop Test	To be measured after dropping from 60cm high on the concrete surface in packing state.  <i>Dropping method corner dropping:</i> <i>A corner: Once edge dropping.</i> <i>B, C, D edge: Once face dropping.</i> <i>E, F, G face: Once.</i>	

- Notes:
1. No dew condensation to be observed.
 2. The function test shall be conducted after 4 hours storage at the normal temperature and humidity after removed from the test chamber.
 3. Vibration test will be conducted to the product itself without putting I in a container.

Product Specification			
	Model: GKTW70SDAE4SE	Rev. No.	Issued Date.
		B	2014.Nov.13
		Page. 22 / 22	

9. Dimensional Outlines

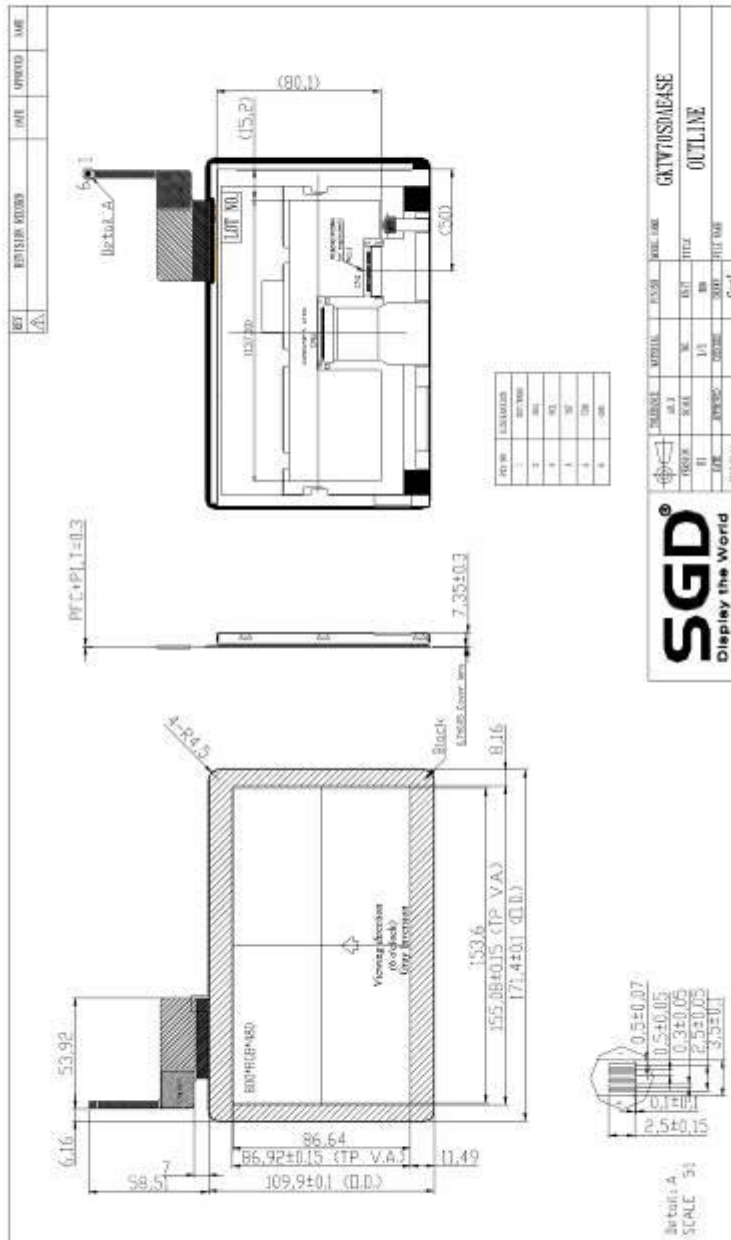

SOLOMON GOLDENTEK DISPLAY CORP. **SGD**